

Article number: 2310304525ESD

Description: E+G Antistatic base for levelling elements
LV.A-80-14-M16x108-ESD-C

Measures

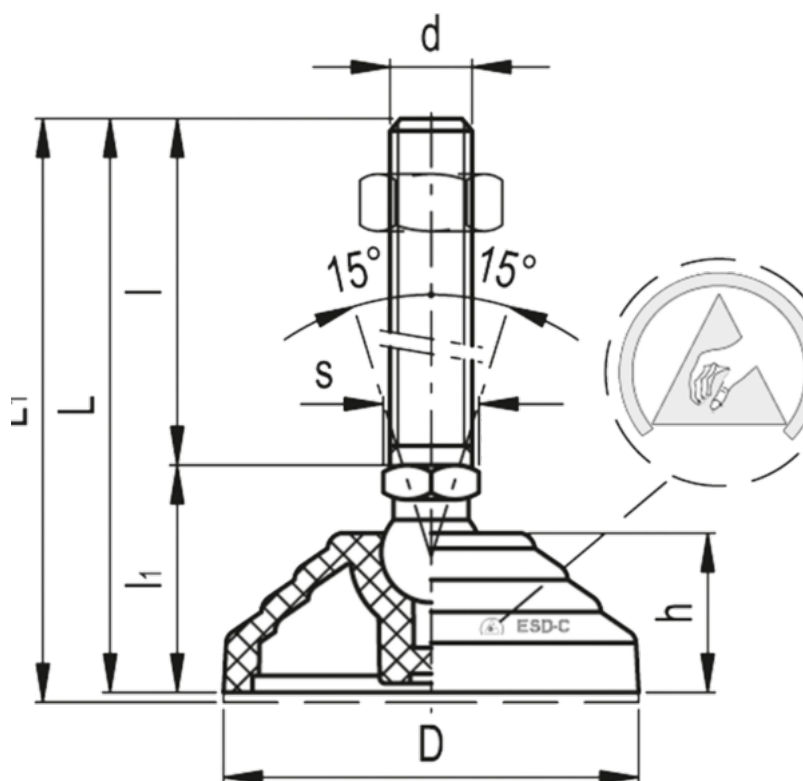

Articulation = 14
D = 80
d = M16
h = 24
l = -
l1 = -
L = 141
Max load = 16000

s = 16
Weight in (g) = 215